

Operation

NO Normally Open



NO or NC rotating the sensor

NC Normally Closed

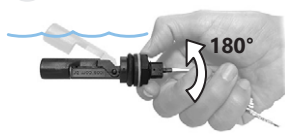

Typical Connection to Contactor

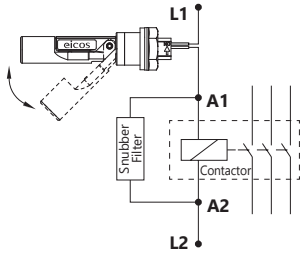

Switch **NO/NC - SPST**
Output **Contact ON/OFF**
Enclosure Rating **IP66**

! Never connect the sensor to a motor, pump, lamp or any other load over 20W. Always use a contactor or relay.

The sensors work in all voltage and current ranges displayed in the table below:

Operating Voltage	Max. Switching Power	Max. Switching Current	Peak Current
110Vac	20VA	0.2A	0.5A @20ms
220Vac	20VA	0.1A	0.5A @20ms
5Vdc	2.5W	0.5A	1A @20ms
12Vdc	5W	0.5A	1A @20ms
24Vdc	10W	0.5A	1A @20ms

24Vdc: Recommended use with Schneider Coupling Relay model RSLZVA1.

Term of Warranty

For installations according to this guide: 02 (two) years warranty. **INCORRECT INSTALLATION CANCELS THE WARRANTY.** All Sensors have been tested and approved during the manufacture process.

Chemical products require tests by the customer to verify compatibility with the constructive material of the sensor.

Liquids with ferrous particles require technical analysis: the Sensor has magnetic component inside.

On datasheets.eicos.us available technical specifications

+55 (15) 3032.9190

Electrical Contact of Sensors - Attention to Install

Reed Switch 20W/VA: Protect the Electrical Contact of your Sensor



Reed Switches are hermetically sealed contacts actuated by a magnetic field.

The life expectancy of a reed switch refers to a kind of load to be used. Reed Switches of the highest reliability are applied in our sensors, and their life expectancy can reach above two million operations. However, when they are switching lamps, inductive or capacitive loads, this number may decrease.

Switching Power

It is important to consider that the power specified by an electrical load is often referred to the permanent working state.

For higher power, use an auxiliary relay or contactor as recommended below, or similar.

Siemens 3RT1015 Contactor

Initial: 31.7VA

Rated: 5.1VA

Note: Reed Switches have reached over one million operations in tests with contactor and K8* snubber filter.

On accessories.eicos.us check models and prices of Filters

Level Switches

Models with Compression Gasket



IMPORTANT !
YOU MUST CHECK BEFORE INSTALLATION

• **AUXILIARY CONTACTOR (mini contactor) mind the distance:**



• **SOLENOID VALVE or POWER CONTACTOR:**
Use *mini contactor* or *auxiliary relay*.

• **ELECTRONIC EQUIPMENT:**
> Interface relay/relay coupler: Use **4K7 10W resistor**.
> Timing relay, level relay and frequency inverter: Use **220R 5W resistor**.

• **CONNECTION WITH CONTACTOR:**

Initial Power Rated Power
Should be less than **20W**.

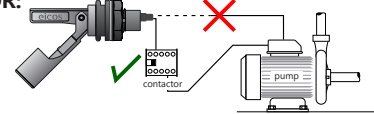

AC Current: Use **K8* Filter** in parallel with the coil (A1 A2) of a contactor or relay.
DC Current: Use **KD* Filter** in parallel with the coil (A1 A2) of a contactor or relay.

*For sale on accessories.eicos.us

Questions? Call us **BEFORE** you install:

+55 (15) 3032.9190

levelsensor.eicos.us | datasheets.eicos.us | videos.eicos.us

PROTECTION PROCEDURES BELOW DESCRIBED CAN IMPROVE THE REED SWITCH PERFORMANCE

• Switching inductive loads

K8* Filter mounted in parallel with the coil of an AC contactor increases the contact life.



KD* Filter mounted in parallel with the coil of a DC relay increases the contact life.

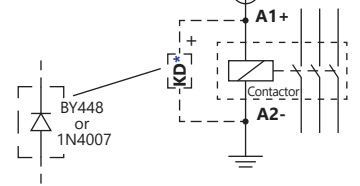
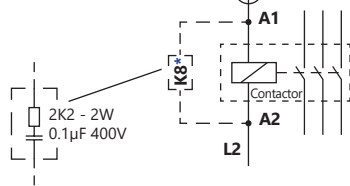

? **Risk of failure (welding of the Reed Switch Contact)** due to CAPACITANCE, which can occur depending on the distance and cable used in the connection to the contactor.

• Connecting the sensor to a contactor in long distances, use resistor:

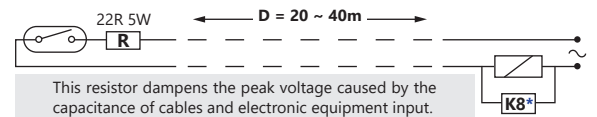

! Important: For distances **greater than 40m**, use 24Vdc voltage.

• Connecting the sensor to an electronic equipment:

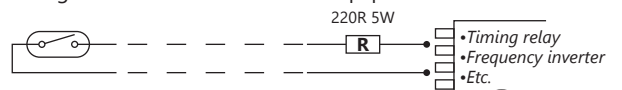

! Important: For installation with **relay coupler**, use 4K7 10W resistor.

For better sealing, the internal surface of the tank must be free of roughness.

External Side Mounting with Compression Gasket in Ø22mm Hole



Technical Specifications	LA322E-40	LA322E-M12	LF222E-40	LF322E-M12
Material	PPA	PPA	PP	PPA
Operating temperature range	-10°C to 125°C	-10°C to 125°C	-10°C to 120°C	-10°C to 125°C
Maximum operating pressure	2bar	2bar	2bar	2bar
Color	Black	Black	Dark blue	Black
Liquid minimum density (SG)	0.70	0.70	0.80	0.66
Sealing (rubber type)	NBR	NBR	EPDM	EPDM
Output connection	40cm cable	M12 plug	40cm cable	M12 plug



- Electrical contact: Reed Switch 20W/VA;
- External mounting in through hole of Ø22mm;
- Sealing: Compression gasket;
- NO or NC, by rotating the sensor 180°.

LA Series

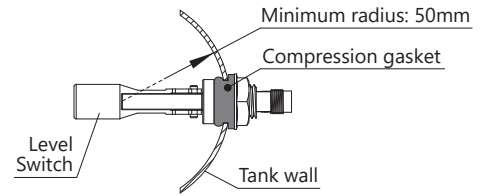
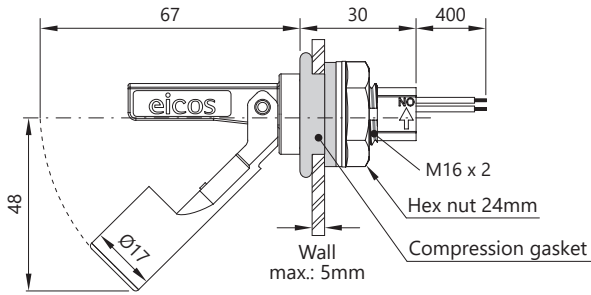

LF Series

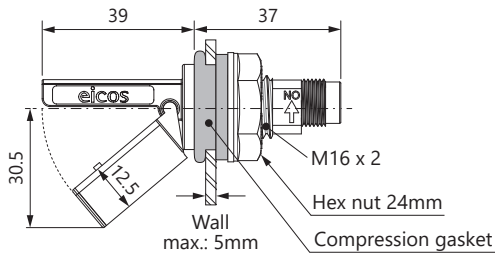

M12 Plug Sensors Installation

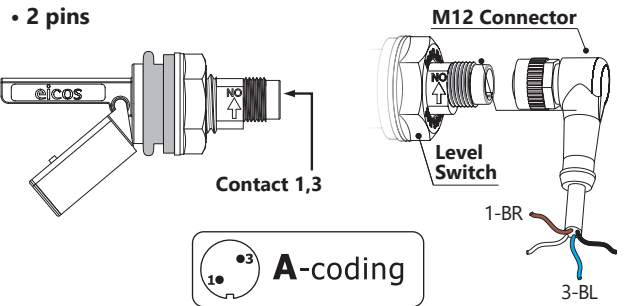

Constructive Materials

PP Polypropylene: Ideal for chemical products. **NOT SUITABLE FOR FUEL.**
PPA Polyphthalamide: Best mechanical and temperature resistance.

Suggestions for Applications

Level Detection Inside Pipes



Radiator Coolant Fluid Level Monitoring

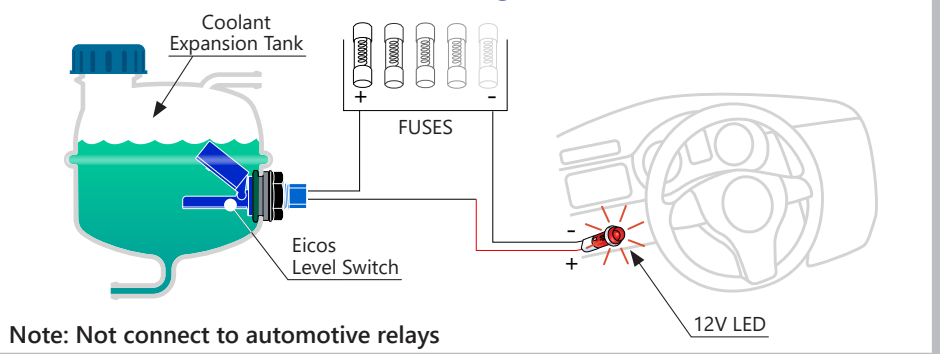

Dimensions in millimeters

On levelsensor.eicos.us check models and prices of Level Switches

Flow Switches and Level Switches for liquids